



Suggested viewing distance is 150-200 cm.

HyPixel™ U1

4K Endoscope Camera System

Simply Clear

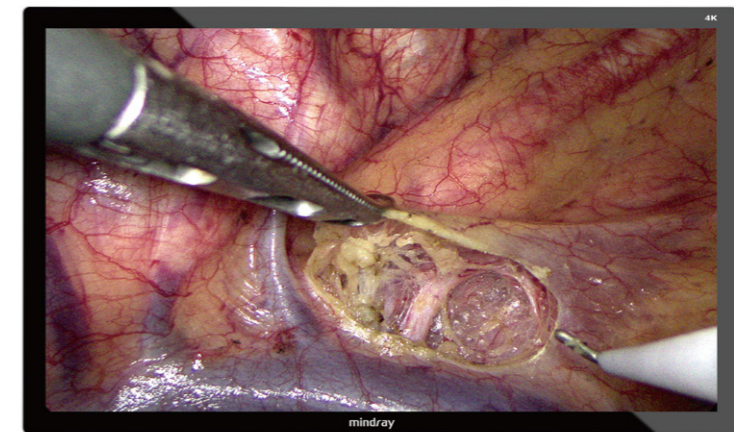

4K ULTRA HD

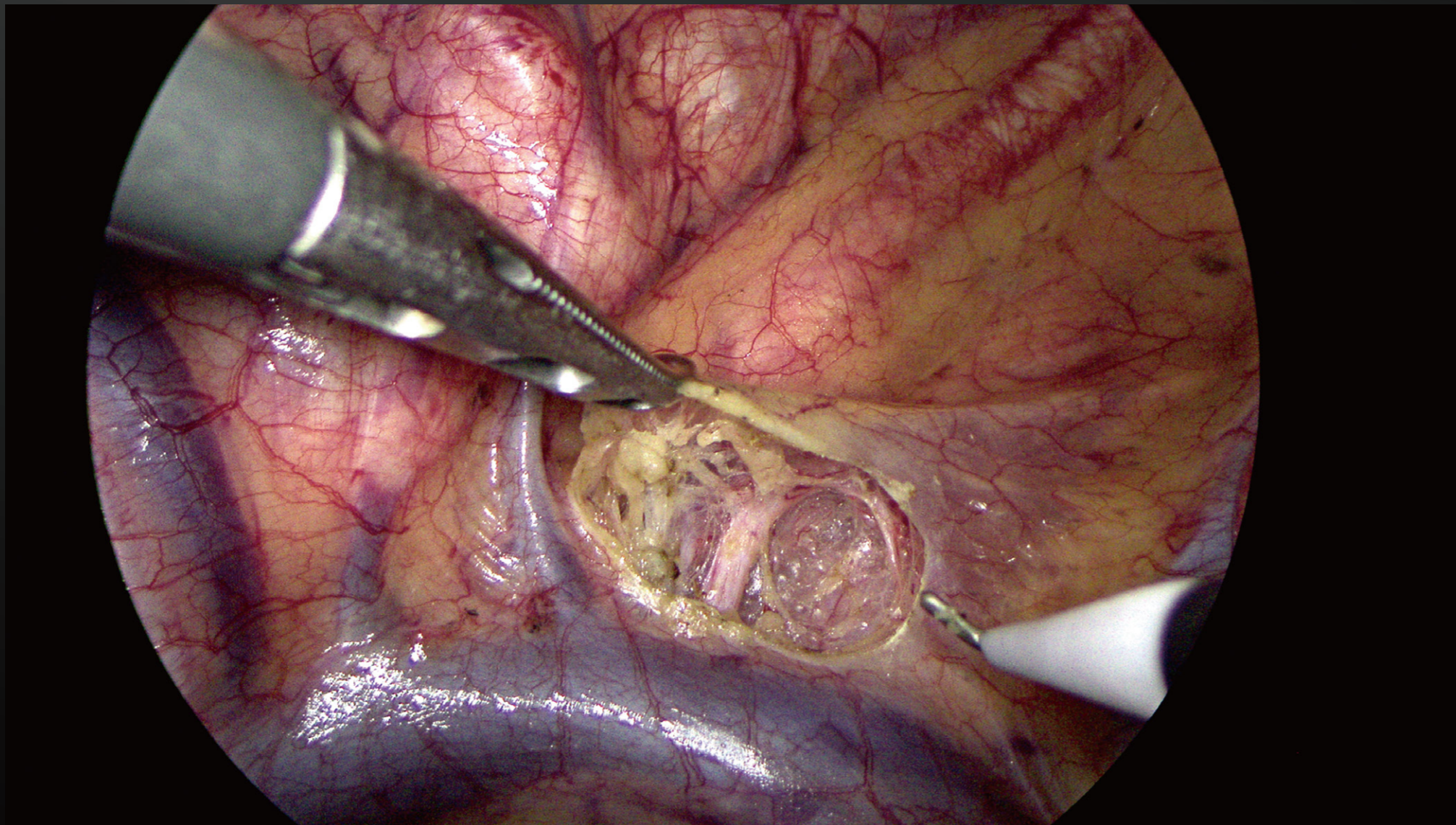

Resolution

- 3840x2160
- Ultra-high-definition image presentation

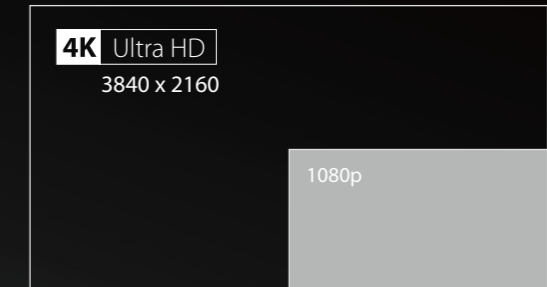

Wide Color Gamut

- Restore the organs and tissues in real color, perfect identification of blood vessels, lymph nodes and nerves.

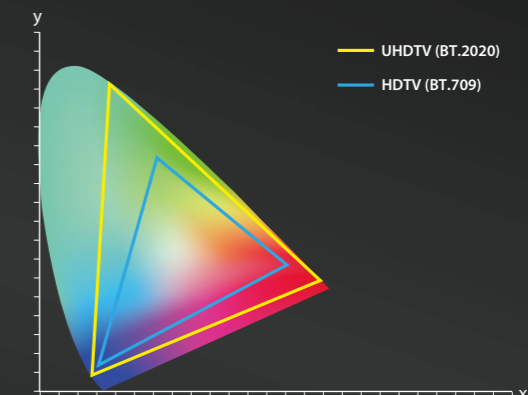

3-200mm Depth of Field

- Within the depth of field, the camera always shows clear image.

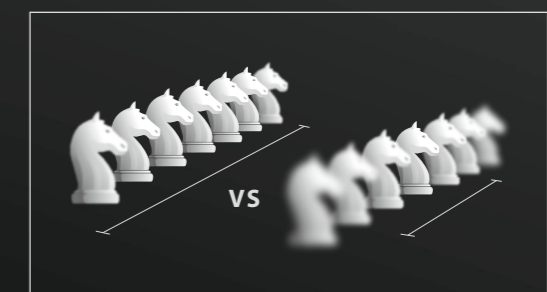

55" inch Immersive Experience



- The 55" screen can provide a large field of view and an immersive experience, which helps doctors get more concentrated and achieve better performance.

- The surgery image is enlarged without losing quality, so that the details are more visible and the surgeons can perform the surgery more easily.

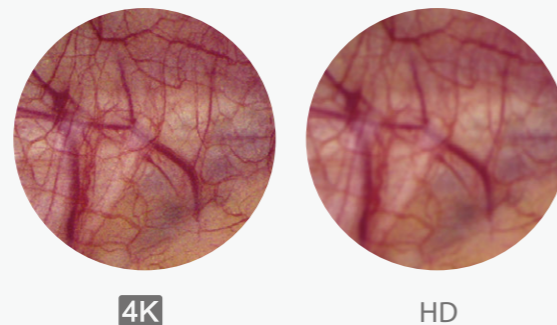
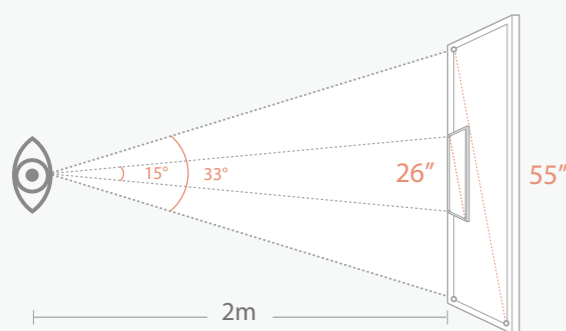

Built-in USB Recording



- The built-in USB recording starts with just one click, and the high-quality video will be saved as Full HD resolution.

- With bookmark function, it is convenient to review and edit video record.

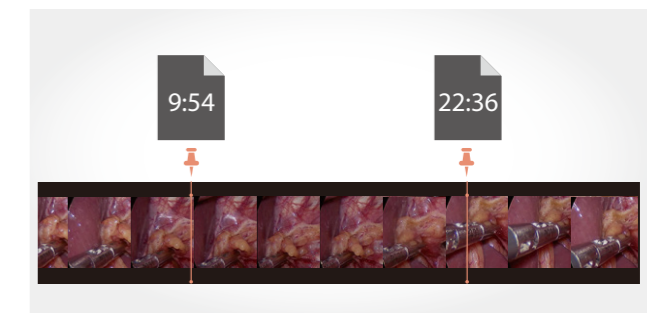

Ergonomics

- **Easy to move**

55" or 31" inch screen and camera system stand on together, which saves OR space and helps the tower move around very easily.



- **Cable Management**

The camera cup holder combined with the cable hook makes storage and management easier.



- **7" Touch Panel**

The main functions are available with only one touch of the panel, and a 10° tilt up screen is easier for observation.



Key Components

Endoscope Camera System U1

- Resolution 3840*2160
- Image enhancement software provides realtime optimization function
- 2x USB slots support up to 2TB flash disk or hard disk storage
- Manual focus ring with 2 programmable buttons on camera head



Endoscope Light Source HB300L

- Brightness is equivalent to Xenon light source
- Meets the requirements of various clinical scenarios
- Lifespan ≥ 60,000 hours
- Touch screen control panel with standby function



Insufflator HS-50F

- Flow rate is up to 50L/m, no more fear of pressure loss caused by suction and leakage
- Heating function keeps the body temperature stable
- Smoke evacuation guarantees the safety of OR staff



Rigid Endoscope

- 4K UHD level image quality
- Unique surface treatment process significantly improves the fogging problem



Autoclavable 134°C

Model	Direction of View	Field of View	Working Length	Depth of View	Autoclavable
M01030A	30°	80°	321mm	3-200mm	Yes
M01000A	0°	80°	321mm	3-200mm	Yes

4K Medical Grade Monitor

- 55" or 31" inch selectable
- Optical bonding technology reduces reflection interference and presents images of real color with high level contrast and brightness

